

KNAPHEIDE
SINCE 1848



GENERAL MOTORS
**ALUMINUM
SERVICE BODIES**

KNAPHEIDE ALUMINUM SERVICE BODIES

Aluminum service bodies from Knapheide feature a superior design and innovative construction.

Utilizing military-grade aluminum and structural adhesives are just a few of the features that place our aluminum service bodies far ahead of the competition.



STANDARD ALUMINUM SERVICE BODIES

In order to provide customers with the utmost confidence in our aluminum service bodies, we put them through the most rigorous testing program in history. They were subjected to the harshest environments and applications possible in our lab, on proving grounds — and by real customers like you.

Choose a Knapheide Aluminum Service Body and you'll get corrosion resistance, increased payload, and an aluminum service bed that is just as durable as steel.

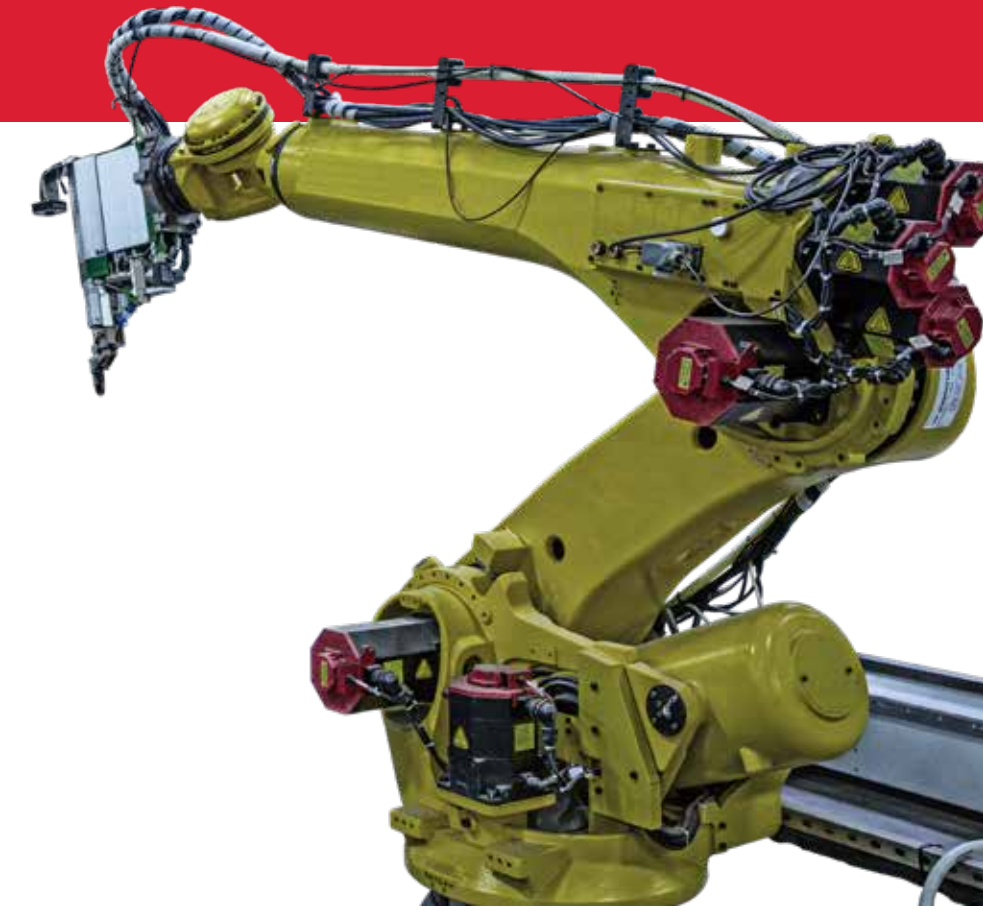

AEROSPACE ASSEMBLY TECHNOLOGY

Assembled entirely from Grade 5 hardware and structural rivets that are coated specifically not to corrode with aluminum materials.

POPULAR VOCATIONS



CONSTRUCTION

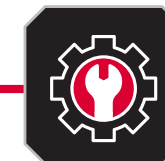

MUNICIPALITIES/
UTILITIES



OIL/MINING/GAS

A. FLOOR CONSTRUCTED OF RUGGED 6061 T6 ALUMINUM EXTRUSIONS AND EXCLUSIVE "RETURN FLANGE" FLOOR DESIGN
 provides support and corrosion resistance

B. ADJUSTABLE SECURITY RING STRIKERS
 provide a weather-tight seal

C. INTERIOR COVER
 protects internal latch from damage

D. SLAM-LOCK TAILGATE
 with one-hand center release

E. UPGRADED SURFACE MOUNT LIGHTING SYSTEM
 features LED S/T/T and B/U, LED strobe option* with (8) selectable patterns, and built-in reflectivity for additional safety**

**Additional wire harness required for strobe lights
 **Lights covered by 3-year limited warranty*



FEATURES NOT SHOWN

CONSTRUCTED OF 6061 T6 & 5052 ALUMINUM
 provides support and corrosion resistance

ALL ALUMINUM 6061 T6 UNDERSTRUCTURE
 provides support and corrosion resistance

TPO FENDER SKIRT

QUICK-MOUNT INSTALLATION
 allows for fast, safe mounting

AUTOMOTIVE-QUALITY ROTARY LATCHES
 with easy open handler

COMPARTMENT FEATURES



NITROGEN STRUT DOOR RETAINERS
 on vertical compartment doors eliminate involuntary swing



INSET DOOR FRAME DESIGN WITH DOUBLE TRAY ALUMINUM DOORS AND NEOPRENE SEALS
 for weather-tight closing



CONTINUOUS ALUMINUM HINGE WITH STAINLESS STEEL RODS
 are pry-proof and corrosion-resistant



INTERIOR LIGHT GUARDS
 protect recessed lighting and wiring

STANDARD SHELVING



STREET AND CURB SIDE FRONT VERTICAL COMPARTMENTS
 Two adjustable divider shelves and dividers, with a 250-lb. capacity (1st and 2nd vertical 132" bodies only)



STREET AND CURB SIDE FULL HEIGHT REAR VERTICAL COMPARTMENTS
 One adjustable divider shelf and dividers, with a 250-lb. capacity



CURB SIDE HORIZONTAL COMPARTMENT
 One adjustable divider shelf and dividers, with a 250-lb. capacity

60" tall bodies include an extra divider shelf in each compartment, including one in the streetside horizontal

COMPARTMENT CONFIGURATIONS



500 SERIES COMPARTMENTS

The 500 Series Service Bodies feature a horizontal compartment that stretches from the first vertical compartment to the end of the body with a small, rear lower compartment.



600 SERIES COMPARTMENTS

The 600 Series Service Bodies feature a horizontal compartment that is positioned over the wheel well and one vertical compartment in the front of the body and one at the rear of the body.



700 SERIES COMPARTMENTS

The 700 Series has 500 Series configuration on the curb side and 600 Series on the street side.



LOW PROFILE BODY

Low Profile Bodies, denoted by "LP", offer greater visibility from the cab while only sacrificing 4" of the body height compared to a standard Service Body.



RAISED FRONT COMPARTMENTS

This configuration raises the curb side front vertical compartment to 60" tall, denoted by "60". "60-L" indicates raised front compartment on the street side (left) of the body, and "60-B" indicates raised front compartments on both sides.

FLIP TOP COMPARTMENTS

Flip Tops, denoted by "F", allow for greater internal storage, organization and flexibility. Knapheide Flip Tops have a slammable top lid door and a convenient one-hand release located in the horizontal compartment.

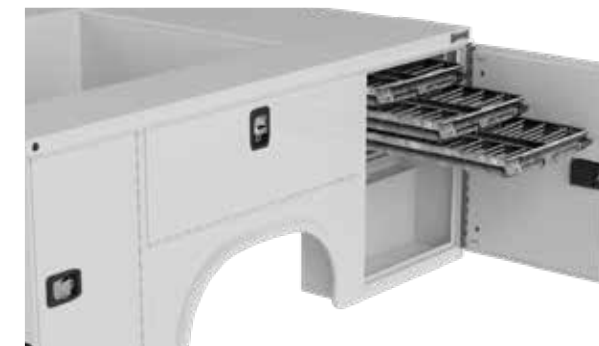

THREE-DRAWER UNIT



TWO-DRAWER UNIT

PLUS 50 TRANSVERSE COMPARTMENTS

Plus 50 models feature a transverse compartment in the curb side front vertical extending to the street side compartment back. Plus 50 models have 50% more effective storage capacity. Models are denoted by "50".

Depending on body model, compartments have either two or three drawers, 59" or 69" long. All drawers are rated for 250-lb. and have dividers every 4".



REQUEST A QUOTE



Visit knapheide.com/quote and fill out the form to receive a quote and additional product information.

POPULAR OPTIONS

BUMPERS

Knapheide bumpers are constructed with work in mind. Available in two configurations with KnapLiner coating for additional friction and durability.



HITCH RECESS BUMPERS



STRAIGHT BUMPERS

UTILITY RACK

Adding a rack to your Service Body increases your storage space by getting your ladders and other long tools or equipment up and out of the way, making room to haul more items in your cargo area.

1,000 lb. capacity - forklift loadable



POPULAR OPTIONS



MASTER LOCKS



POWER LOCKS



FRONT STROBE



LED COMPARTMENT LIGHTS



GRAB HANDLES



CABLE STEPS



ALUMINUM DRAWERS



CARGO TIE-DOWNS



ROCK GUARDS



ALUMINUM TREAD PLATE TRIM KITS



PULL-OUT TRAY



MODULAR CAB GUARD



METER TRAY WITH HOLES



SINGLE POINT OR THREE POINT T-HANDLE



REAR ACCESS DOOR

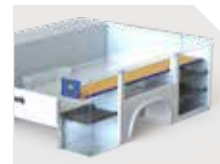

REAR ACCESS DOOR WITH FULL-LENGTH SHELF



E-TRACK & ACCESSORIES



BOTTLE GAS RETAINER

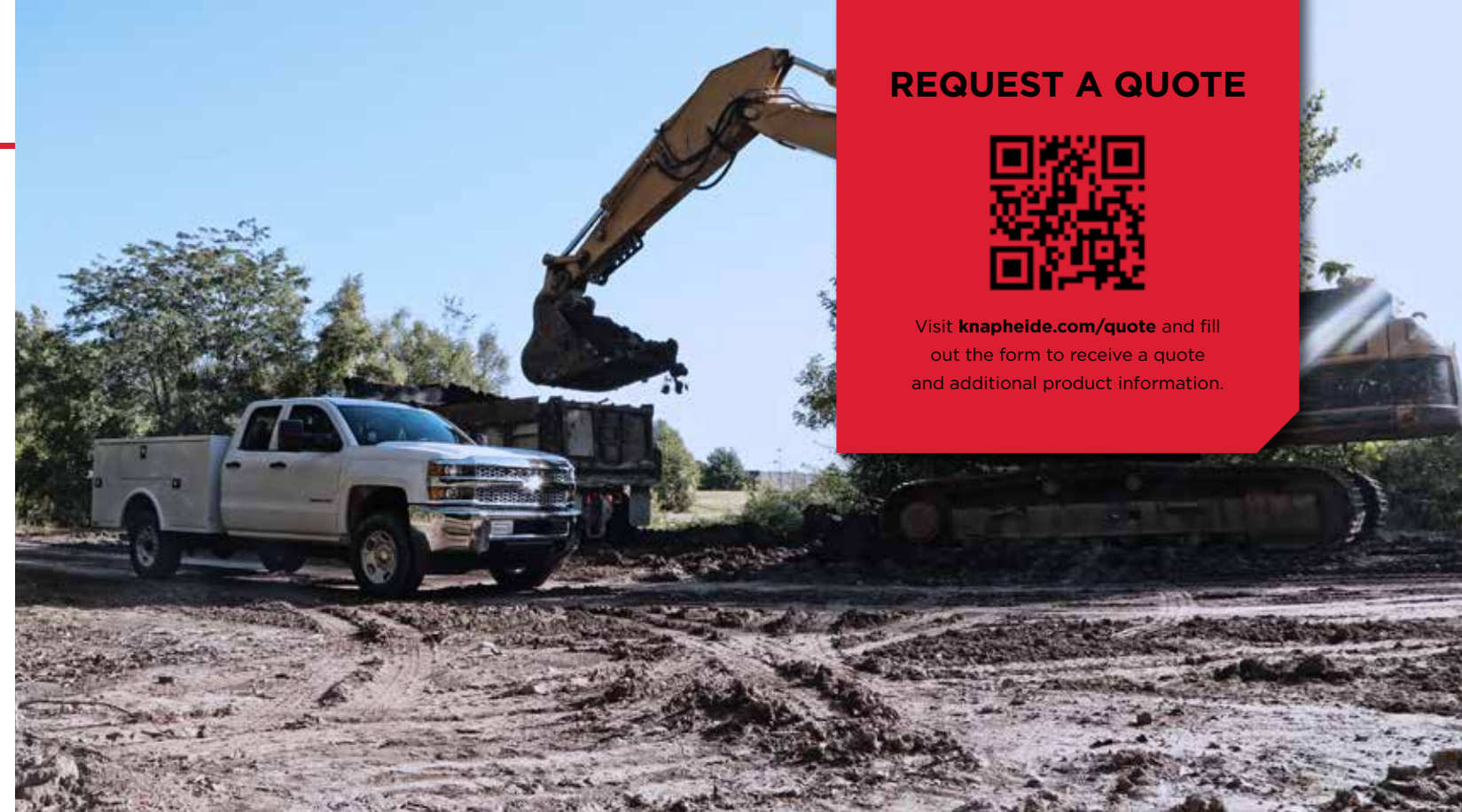

REQUEST A QUOTE



Visit knapheide.com/quote and fill out the form to receive a quote and additional product information.

REAR LIFTGATE



MODEL OPTIONS

36" CA SINGLE REAR WHEEL

MODEL	TYPE	HEIGHT	WEIGHT	TRUCK	CAB	WHEELBASE	GVWR
A676LP	Low Profile	36"	431 lb.	T2M53	Double Cab	128.3"	5,400/5,700 lb.
A676F	Flip Top	37.25"	507 lb.				

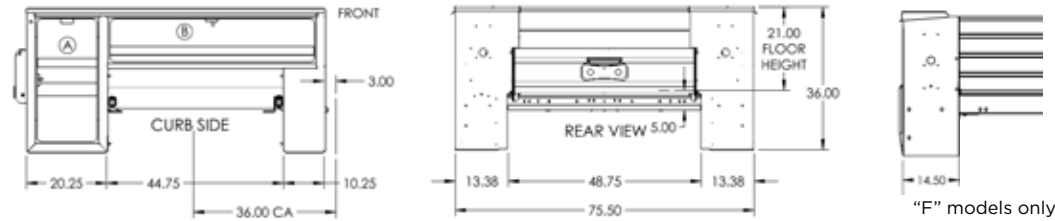

42" CA SINGLE REAR WHEEL

MODEL	TYPE	HEIGHT	WEIGHT	TRUCK	CAB	WHEELBASE	GVWR
A684	Standard	40"	519 lb.	C/K20753	Double Cab	149.4"	10,100/11,200 lb.
A684LP	Low Profile	36"	492 lb.	C/K20743	Crew	158.9"	10,000/11,750 lb.
A684F	Flip Top (L)	37.25"	573 lb.	C/K30743	Crew	158.9"	11,000/12,100 lb.
A684F40	Flip Top (H)	41.25"	600 lb.				

Note: Chassis 10,000 lb. GVWR and under are not applicable for pickup box removal

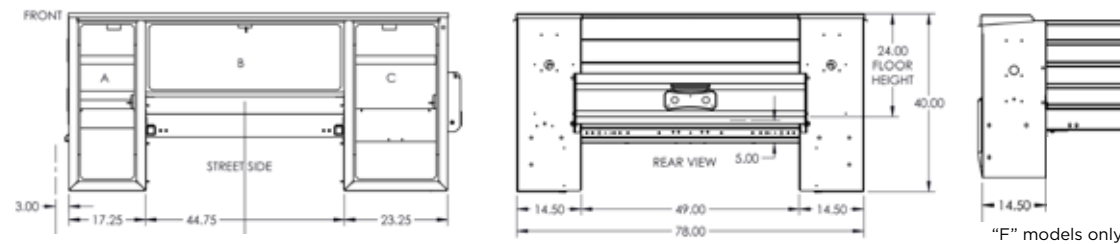

56" CA SINGLE REAR WHEEL

MODEL	TYPE	HEIGHT	WEIGHT	TRUCK	CAB	WHEELBASE	GVWR
A698	Standard	40"	588 lb.	C/K30903	Regular	141.5"	11,000/11,800 lb.
A698LP	Low Profile	36"	559 lb.	C/K30953	Double Cab	158.2"	11,400/12,150 lb.
A698F	Flip Top (L)	37.25"	652 lb.	C/K30943	Crew	167.7"	11,500/12,250 lb.
A698F40	Flip Top (H)	41.25"	681 lb.	C/K20903	Regular	141.5"	9,900/11,200 lb.
A698D38	Standard	40"	610 lb.	C/K20953	Double Cab	162.5"	9,900/11,450 lb.
A698D38LP	Low Profile	36"	582 lb.	C/K20943	Crew	172"	9,900/11,550 lb.
A698D38F	Flip Top (L)	37.25"	696 lb.				
A698D38F40	Flip Top (H)	41.25"	709 lb.				

* not compatible 1500 chassis

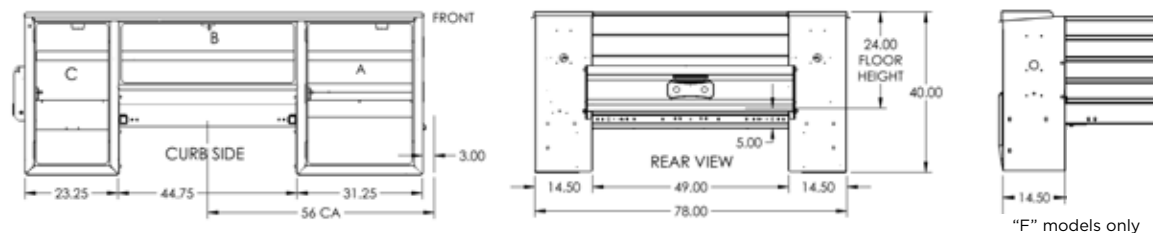

56" CA DUAL REAR WHEEL

MODEL	TYPE	HEIGHT	WEIGHT	TRUCK	CAB	WHEELBASE	GVWR
A698D54	Standard	40"	551.35 lb.	C/K30903	Regular	141.6"	14,000 lb.
A698D54LP	Low Profile	36"	601.09 lb.	C/K30953	Double Cab	162.5"	14,000 lb.
A698D54F	Flip Top (L)	37.25"	656.97 lb.	C/K30943	Crew	172"	14,000 lb.
A698D54F40	Flip Top (H)	41.25"	675.86 lb.				

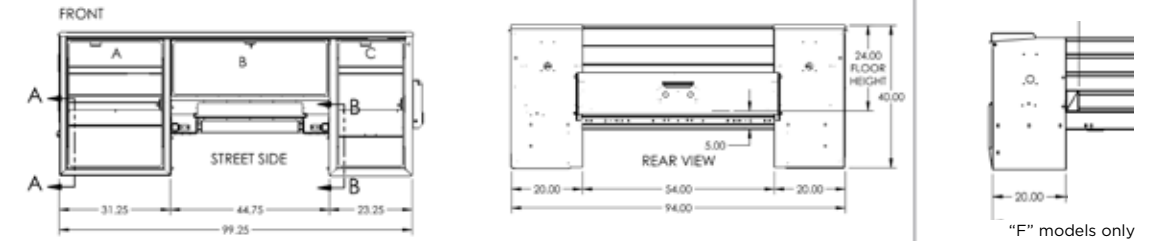

60" CA DUAL REAR WHEEL

MODEL	TYPE	HEIGHT	WEIGHT	TRUCK	CAB	WHEELBASE	GVWR
A6110D49	Standard	40"	575.03 lb.	C/K31003	Regular	146.3"	14,000 lb.
A6110D49LP	Low Profile	36"	553.38 lb.	C/K31043	Crew	176.8"	14,000 lb.
A6110D49F	Flip Top (L)	37.25"	688.63 lb.	C/K56403	Regular	141"	15,000/22,940 lb.
A6110D49F40	Flip Top (H)	41.25"	717.48 lb.	C/K36043	Crew	175"	15,000/22,940 lb.
A6110D54	Standard	40"	593.25 lb.				
A6110D54LP	Low Profile	36"	573.39 lb.				
A6110D54F	Flip Top (L)	37.25"	872 lb.				
A6110D54F40	Flip Top (H)	41.25"	907 lb.				
A6110D54H46	Standard	46"	747 lb.				
A6110D54H60	Standard	60"	902 lb.				

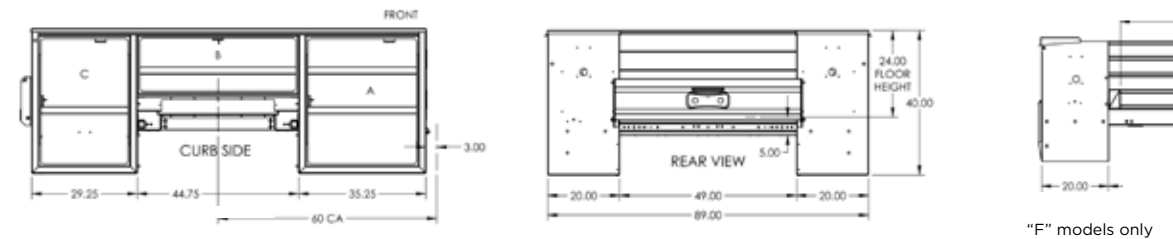

84" CA DUAL REAR WHEEL

MODEL	TYPE	HEIGHT	WEIGHT	TRUCK	CAB	WHEELBASE	GVWR
A6132D49	Standard	40"	668.69 lb.	C/K31403	Regular	170.8"	14,000 lb.
A6132D49LP	Low Profile	36"	656.7 lb.	C/K56403	Regular	165"	15,000/22,940 lb.
A6132D49F	Flip Top (L)	37.25"	923.8 lb.	C/K56043	Crew	199"	15,000/22,940 lb.
A6132D49F40	Flip Top (H)	41.25"	966.91 lb.				
A613D54	Standard	40"	687.32 lb.				
A613D54LP	Low Profile	36"	677.13 lb.				
A6113D54F	Flip Top (L)	37.25"	853.86 lb.				
A6113D54F40	Flip Top (H)	41.25"	981.12 lb.				
A6132D54H46	Standard	46"	888 lb.				
A6132D54H60	Standard	60"	1,070 lb.				

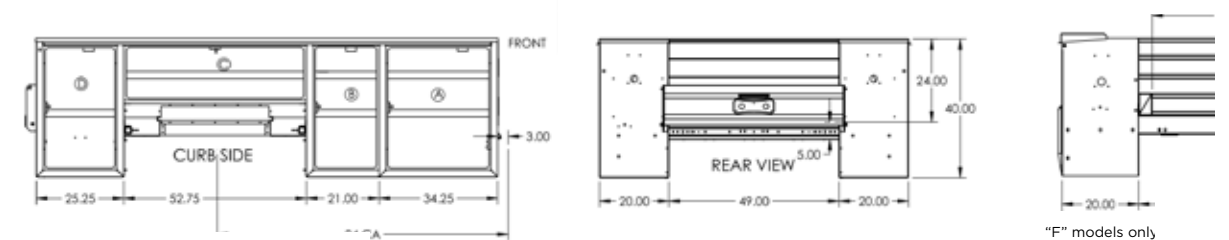

COMMITMENT TO CORROSION RESISTANCE

Aluminum bodies are naturally corrosion resistant. Where steel fasteners are used, those fasteners are coated with "EcoGuard" to eliminate the interaction between the steel and aluminum.

This aluminum assembly method both allows us to create products with the highest level of corrosion resistance available.



FOLLOW US
LIKE US
TAG US



TEN YEAR, LIMITED TIME WARRANTY



**NO RUST
THROUGH**



**DOOR HINGES
WILL NOT FAIL OR
COME OFF BODY**



**LATCHES AND LOCK
CYLINDERS WILL NOT
FAIL TO OPERATE**



**SHELVES WILL NOT
BEND UNDER MAX.
LOAD OF 250 LBS.**

TO LEARN MORE VISIT
www.knapheide.com/warranty



NEVER SETTLE

If you are going to be a leader, it takes more than building a high-quality product. It means never being totally satisfied with that product, no matter how high quality it may be. It requires constant vigilance and a willingness to take a chance on something new. And it means exceeding expectations every time. As the industry changes, one thing never will—our commitment to making customers like you as productive and efficient as possible. We know you don't settle, and we don't either. That's why we want you never to settle for anything less than Knapheide on the back of your truck.

KNAPHEIDE. NEVER SETTLE.



The Knapheide Manufacturing Company
1848 Westphalia Strasse | Quincy, IL 62305
217-222-7131
www.knapheide.com