

**KNAPHEIDE**  
SINCE 1848

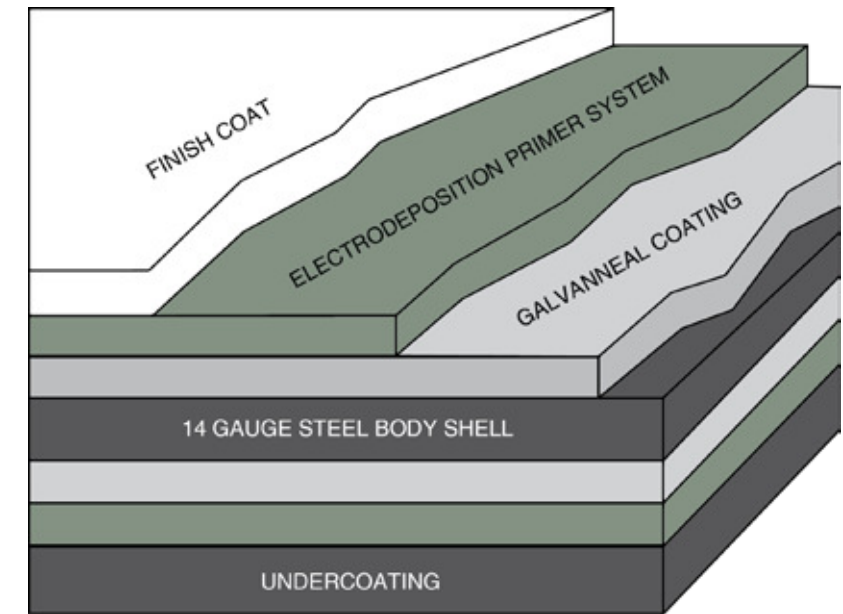

RAM  
**STEEL**  
**SERVICE BODIES**

# KNAPHEIDE STEEL SERVICE BODIES



## SERVICE BODY STEEL SHELL

Rugged two-sided A-40 galvalume steel body shell with a six year warranty. Complete undercoating provides an additional layer of corrosion protection.

## STANDARD STEEL SERVICE BODIES

With a rugged steel construction and external storage for your tools and equipment, the Service Body is a key component in your day-to-day productivity.

The external compartments offer protection from outside elements and allow technicians to access their equipment without having to climb into the truck bed.

Staying organized both on and between job sites is important. Get maximum efficiency with a Knapheide Service Body.

## POPULAR VOCATIONS



CONSTRUCTION

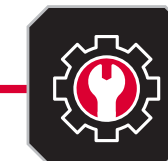

MUNICIPALITIES/  
UTILITIES



OIL/MINING/GAS

**A. DOUBLE-SHELL, 20-GAUGE, TWO-SIDED A-40 GALVANNEAL STEEL**  
compartment doors

**B. ADJUSTABLE SECURITY RING STRIKERS**  
provide a positive locking engagement of the door resulting in a weather tight seal

**C. INTERIOR COVER**  
protects internal latch from damage

**D. SLAM-LOCK TAILGATE**  
with one-hand center release

**E. UPGRADED SURFACE MOUNT LIGHTING SYSTEM**  
features LED S/T/T and B/U, LED strobe option\* with (8) selectable patterns, and built-in reflectivity for additional safety\*\*

\*Additional wire harness required for strobe lights  
\*\*Lights covered by 3-year limited warranty



Note: Body may be shown with optional features.

FEATURES NOT SHOWN

**EXCLUSIVE "RETURN FLANGE" FLOOR DESIGN**  
provides support

**E-COAT PROTECTION**  
Knapheide Bodies are fully immersed in Knapheide's 12-step, electrodeposition prime paint system for superior corrosion resistance.

**QUICK-MOUNT INSTALLATION**  
allows for fast, safe mounting

COMPARTMENT FEATURES



**DOUBLE-SPRING OVER-CENTER RETAINER**  
on vertical compartment doors eliminate involuntary swing



**NEOPRENE DOOR SEALS**  
protect compartments from the weather



**CONTINUOUS STAINLESS STEEL HINGES**  
are pry-proof and corrosion-resistant



**INTERIOR LIGHT GUARDS**  
protect recessed lighting and wiring

STANDARD SHELVING



**STREET AND CURB SIDE FRONT VERTICAL COMPARTMENTS**  
Two adjustable divider shelves and dividers, with a 250-lb. capacity (1st and 2nd vertical 132" bodies only)



**STREET AND CURB SIDE FULL HEIGHT REAR VERTICAL COMPARTMENTS**  
One adjustable divider shelf and dividers, with a 250-lb. capacity



**CURB SIDE HORIZONTAL COMPARTMENT**  
One adjustable divider shelf and dividers, with a 250-lb. capacity

60" tall bodies include an extra divider shelf in each compartment, including one in the streetside horizontal

# COMPARTMENT CONFIGURATIONS



## 500 SERIES COMPARTMENTS

The 500 Series Service Bodies feature a horizontal compartment that stretches from the first vertical compartment to the end of the body with a small, rear lower compartment.



## 600 SERIES COMPARTMENTS

The 600 Series Service Bodies feature a horizontal compartment that is positioned over the wheel well and one vertical compartment in the front of the body and one at the rear of the body.

## FLIP TOP COMPARTMENTS

Flip Tops, denoted by "F", allow for greater internal storage, organization and flexibility. Knapheide Flip Tops have a slammable top lid door and a convenient one-hand release located in the horizontal compartment.



## 700 SERIES COMPARTMENTS

The 700 Series has 500 Series configuration on the curb side and 600 Series on the street side.

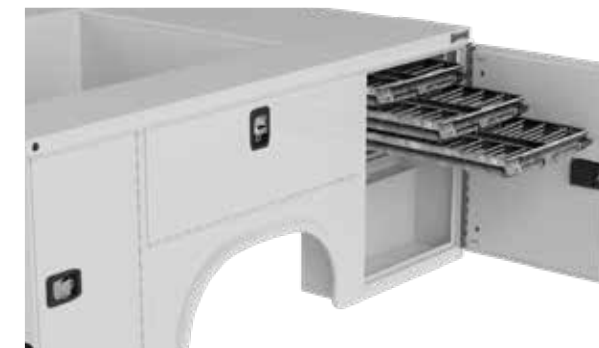

THREE-DRAWER UNIT



TWO-DRAWER UNIT

## PLUS 50 TRANSVERSE COMPARTMENTS

Plus 50 models feature a transverse compartment in the curb side front vertical extending to the street side compartment back. Plus 50 models have 50% more effective storage capacity. Models are denoted by "50".

Depending on body model, compartments have either two or three drawers, 59" or 69" long. All drawers are rated for 250-lb. and have dividers every 4".



## LOW PROFILE BODY

Low Profile Bodies, denoted by "LP", offer greater visibility from the cab while only sacrificing 4" of the body height compared to a standard Service Body.



## RAISED FRONT COMPARTMENTS

This configuration raises the curb side front vertical compartment to 60" tall, denoted by "60". "60-L" indicates raised front compartment on the street side (left) of the body, and "60-B" indicates raised front compartments on both sides.

# POPULAR OPTIONS

## BUMPERS

Knapheide bumpers are constructed with work in mind. With three configurations, we have a bumper for every need. Select bumpers available with KnapLiner coating for additional friction and durability.



**HITCH RECESS BUMPERS**



**STEP BUMPERS**



**STRAIGHT BUMPERS**

## CANOPY ROOF

The canopy roof option allows you to fully enclose your cargo area. Canopy roofs are available in three heights, straight sides, and with stationary or telescopic roofs. Full width roofs are also available. For a tapered-side one-piece body design, take a look at our KUVcc product line.



**STRAIGHT SIDES**



**TELESCOPIC ROOF**



**SIDE ACCESS DOORS**



**SIDE LADDER RACKS**



**REAR ACCESS DOOR**



## TELESCOPIC SLIDING ROOF

Telescopic sliding roofs offer a robust enclosure for the cargo space of your Service Body, allowing you to protect your tools and equipment from theft and weather.

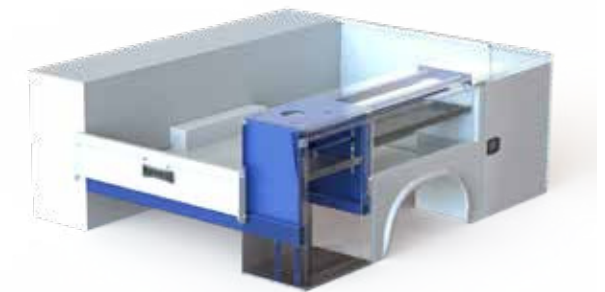

## CRANE REINFORCEMENT KIT

The crane reinforcement kit option allows you to incorporate a crane up to 4,000 lb. capacity (16,000 ft-lb. max.) onto the rear curb side corner of your body.

## RACKS

Adding a rack to your Service Body increases your storage space by getting your ladders and other long tools or equipment up and out of the way, making room to haul more items in your cargo area.



**UTILITY RACK**  
1,000 lb. capacity -  
forklift loadable



**SIDE MOUNT LADDER RACK**  
150 lb. capacity

NOT PICTURED (APPLIES TO SIDE MOUNT & OVERHEAD LADDER RACKS):

**LADDER RACK ROLLERS**

**LADDER RACK RAILS**



**OVERCAB MATERIAL RACK**  
Kargo Master



**OVERHEAD LADDER RACK**  
300 lb. capacity

# POPULAR OPTIONS



**MASTER LOCKS**



**POWER LOCKS**



**FRONT STROBE**



**LED COMPARTMENT LIGHTS**



**FLEX STEPS**



**CABLE STEPS**



**ALUMINUM DRAWERS**



**STEEL DRAWERS**



**ALUMINUM TREAD PLATE TRIM KITS**



**PULL-OUT SHELVES**



**SORTIMO COMPARTMENT STORAGE/MOBILITY**



**ROCK GUARDS**



**MOUNTING KITS FOR REMOVABLE CRANE (SPITZLIFT)**



**METER TRAY WITH HOLES**



**PULL-OUT TRAY**



**MODULAR CAB GUARD**

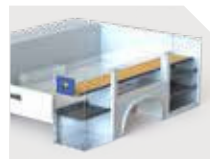

**REAR ACCESS DOOR WITH FULL-LENGTH SHELF**



**E-TRACK & ACCESSORIES**



**SINGLE POINT OR THREE POINT T-HANDLE**



**REAR ACCESS DOOR**



**GRAB HANDLES**



**BOTTLE GAS RETAINER**



**WHEEL CHOCK HOLDER - FENDER SKIRT**



**CARGO TIE-DOWNS**



**REQUEST A QUOTE**



Visit [knapheide.com/quote](https://knapheide.com/quote) and fill out the form to receive a quote and additional product information.

# MODEL OPTIONS

## 56" CA SINGLE REAR WHEEL

MODEL	TYPE	HEIGHT	WEIGHT
696	Standard	40"	1,048 lb.
696LP	Low Profile	36"	993 lb.
696F	Flip Top (L)	37.25"	1,125 lb.
696F40	Flip Top (H)	41.25"	1,181 lb.
696D38*	Standard	40"	1,064 lb.
696D38LP*	Low Profile	36"	1,005 lb.
696D38F*	Flip Top	37.25"	1,142 lb.

TRUCK <sup>1</sup>	CAB	WHEELBASE	GVWR <sup>2</sup>
2500	Regular	140.5"	10,000 lb.
2500	Crew	169.5"	10,000 lb.
3500	Regular	140.5"	10,700/11,500 lb.
3500	Crew	169.5"	10,700/11,500 lb.

<sup>1</sup>All can be ordered with the 56 CA Ram mounting design option for a closer cab fit on Ram 56 CA trucks.  
<sup>2</sup>Chassis 10,000 lb. GVWR and under subject to unloaded vehicle weight limits

\*D38 models denote 38" wide floor and 20" deep compartments

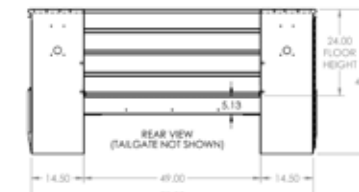
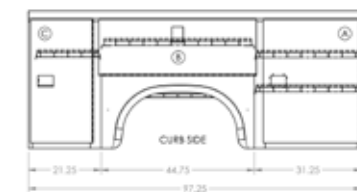

"F" models only

## 56" CA DUAL REAR WHEEL

MODEL	TYPE	HEIGHT	WEIGHT
696D54	Standard	40"	1,205 lb.
696D54LP	Low Profile	36"	1,146 lb.
696D54F	Flip Top (L)	37.25"	1,279 lb.
696D54F40	Flip Top (H)	41.25"	1,339 lb.
696D5460	Standard	40"	1,272 lb.

TRUCK <sup>1</sup>	CAB	WHEELBASE	GVWR
3500	Crew	169.5"	14,000 lb.
3500	Regular	140.5"	14,000 lb.

<sup>1</sup>All can be ordered with the 56 CA Ram mounting design option for a closer cab fit on Ram 56 CA trucks.

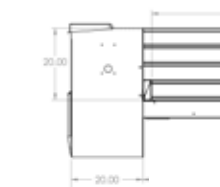
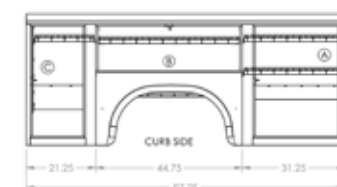

"F" models only

# MODEL OPTIONS

## 60" CA SINGLE REAR WHEEL

MODEL	TYPE	HEIGHT	WEIGHT
6108	Standard	40"	1,147 lb.
6108LP	Low Profile	36"	1,094 lb.
6108F	Flip Top (L)	37.25"	1,239 lb.
6108F40	Flip Top (H)	41.25"	1,295 lb.

TRUCK	CAB	WHEELBASE	GVWR <sup>2</sup>
3500	Regular	143.3"	10,000/12,000 lb.
3500	Crew	172.2"	10,000/12,000 lb.

<sup>2</sup>Chassis 10,000 lb. GVWR and under subject to unloaded vehicle weight limits

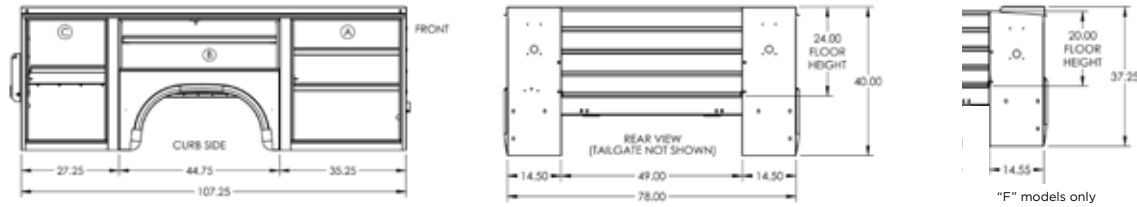

## 84" CA DUAL REAR WHEEL

MODEL	TYPE	HEIGHT	WEIGHT
6132D54	Standard	40"	1,590 lb.
6132D54LP	Low Profile	36"	1,518 lb.
6132D54F	Flip Top (L)	37.25"	1,710 lb.
6132D54F40	Flip Top (H)	41.25"	1,785 lb.
6132D54H46*	Standard	46"	1,709 lb.
6132D54H60*	Standard	60"	1,986 lb.

TRUCK	CAB	WHEELBASE	GVWR
3500	Regular	167.3"	13,500/14,000 lb.
4500	Regular	168.7"	15,000/16,500 lb.
4500	Crew	197.4"	15,000/16,500 lb.
5500	Regular	168.7"	18,000/19,500 lb.
5500	Crew	197.5"	18,000/19,500 lb.

\*46" and 60" tall bodies have overlap doors on horizontal compartments

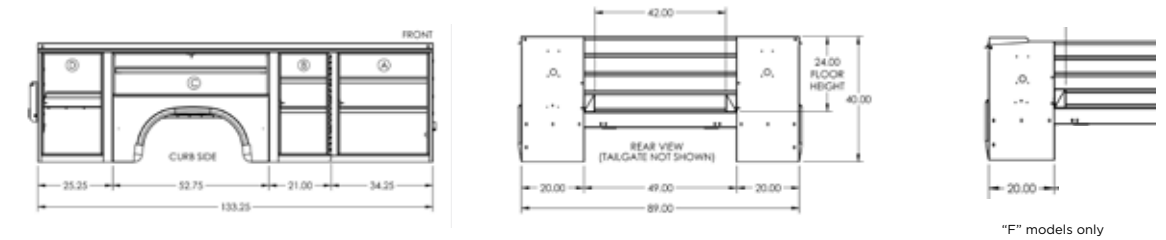

## 60" CA DUAL REAR WHEEL

MODEL	TYPE	HEIGHT	WEIGHT
6108D54	Standard	40"	1,306 lb.
6108D54LP	Low Profile	36"	1,245 lb.
6108D54F	Flip Top (L)	37.25"	1,391 lb.
6108D54F40	Flip Top (H)	41.25"	1,452 lb.
6108-50D54F	Flip Top (L)	37.25"	1,627 lb.
6108-50D54LP	Low Profile	36"	1,485 lb.
6108D54H46*	Standard	46"	1,411 lb.
6108D54H60*	Standard	60"	1,647 lb.

TRUCK	CAB	WHEELBASE	GVWR
3500	Regular	143.5"	13,500/14,000 lb.
3500	Crew	172.4"	13,500/14,000 lb.
4500	Regular	144.6"	15,000/16,500 lb.
4500	Crew	173.5"	15,000/16,500 lb.
5500	Regular	144.6"	18,000/19,500 lb.
5500	Crew	173.5"	18,000/19,500 lb.

\*46" and 60" tall bodies have overlap doors on horizontal compartments

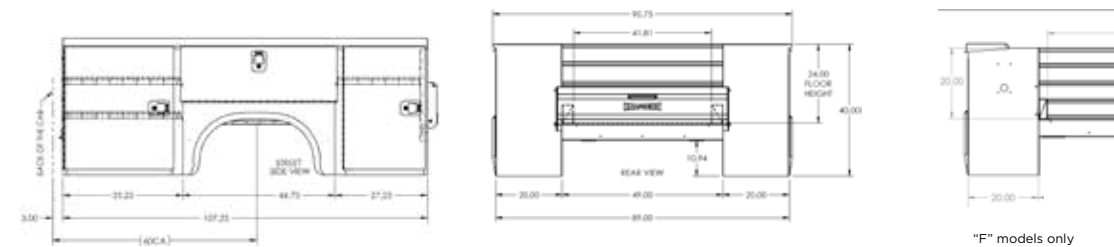

## 108" CA DUAL REAR WHEEL

MODEL	TYPE	HEIGHT	WEIGHT
6157D54	Standard	40"	1,920 lb.

TRUCK	CAB	WHEELBASE	GVWR
4500	Regular	192.5"	18,000/19,500 lb.
5500	Regular	192.5"	18,000/19,500 lb.

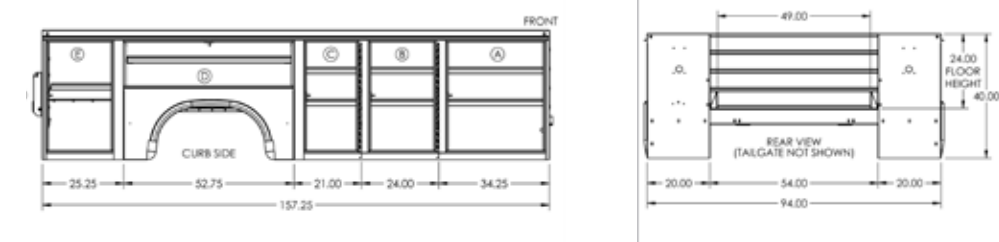

## 81" CA DUAL REAR WHEEL - RAM PROMASTER

MODEL	TYPE	HEIGHT	WEIGHT
6129-RP	Standard	43"	1,505 lb.

TRUCK	CAB	GVWR
VF3L02	Regular	9,350 lb.

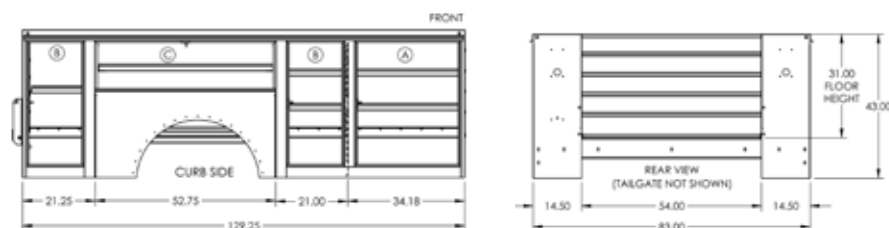

# COMMITMENT TO CORROSION RESISTANCE

Corrosion won't be a concern when you buy quality Knapheide products. To give you the best corrosion protection, we utilize a state-of-the-art, custom-designed, 12-step, SST cathodic electrodeposition finishing system, called "E-Coat."

It bonds prime paint to steel by an electroplating process to give you a superior coat of primer, resulting in better corrosion protection compared to spraying methods.

This system allows us to create products with the highest level of corrosion resistance available.



FOLLOW US  
LIKE US  
TAG US



## SIX YEAR, LIMITED TIME WARRANTY



**NO RUST  
THROUGH**



**DOOR HINGES  
WILL NOT FAIL OR  
COME OFF BODY**



**LATCHES AND LOCK  
CYLINDERS WILL NOT  
FAIL TO OPERATE**



**SHELVES WILL NOT  
BEND UNDER MAX.  
LOAD OF 250 LBS.**

TO LEARN MORE VISIT  
[www.knapheide.com/warranty](http://www.knapheide.com/warranty)





## NEVER SETTLE

If you are going to be a leader, it takes more than building a high-quality product. It means never being totally satisfied with that product, no matter how high quality it may be. It requires constant vigilance and a willingness to take a chance on something new. And it means exceeding expectations every time. As the industry changes, one thing never will—our commitment to making customers like you as productive and efficient as possible. We know you don't settle, and we don't either. That's why we want you never to settle for anything less than Knapheide on the back of your truck.

**KNAPHEIDE. NEVER SETTLE.**



The Knapheide Manufacturing Company  
1848 Westphalia Strasse | Quincy, IL 62305  
217-222-7131  
[www.knapheide.com](http://www.knapheide.com)